

SS14F-HF Thru. SS120F-HF

Reverse Voltage: 40 to 200 Volts

Forward Current: 1.0 Amp

RoHS Device

Halogen Free

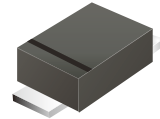

Features

- Metal silicon junction, majority carrier conduction.
- For surface mounted applications.
- Low power loss, high efficiency.
- High forward surge current capability.
- For use in low voltage, high frequency inverters, free wheeling, and polarity protection applications.

Mechanical data

- Case: SMAF
- Terminals: Solderable per MIL-STD-750, method 2026.

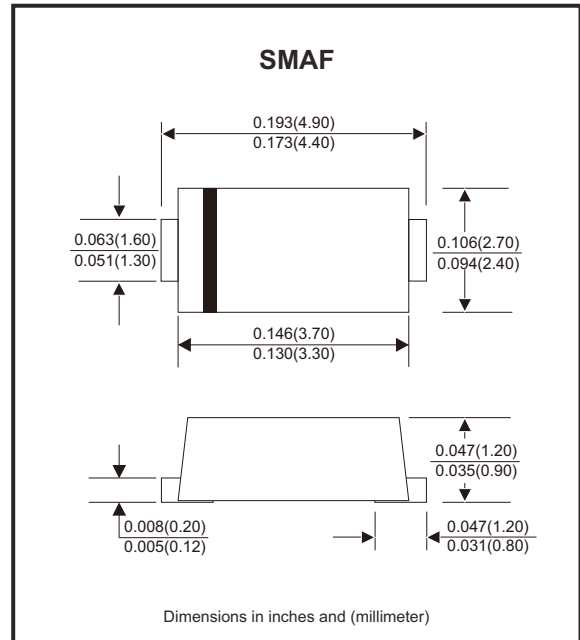

Circuit Diagram



Maximum Ratings and Electrical Characteristics

Ratings at 25°C ambient temperature unless otherwise specified.
Single phase, half wave, 60Hz resistive or inductive load, for capacitive load, derate by 20%

Parameter	Symbols	SS14F-HF	SS16F-HF	SS110F-HF	SS115F-HF	SS120F-HF	Units
Maximum repetitive peak reverse voltage	V_{RRM}	40	60	100	150	200	V
Maximum RMS voltage	V_{RMS}	28	42	70	105	140	V
Maximum DC blocking voltage	V_{DC}	40	60	100	150	200	V
Maximum average forward rectified current	$I_{F(AV)}$	1					A
Peak forward surge current, 8.3ms single half sine-wave superimposed on rated load (JEDEC method)	I_{FSM}	25					A
Max instantaneous forward voltage at 1A	V_F	0.55	0.70	0.85	0.90		V
Maximum DC reverse current $T_J = 25^\circ\text{C}$ at rated DC reverse voltage $T_J = 100^\circ\text{C}$	I_R	0.3 10		0.2 5	0.1 2		mA
Typical junction capacitance (Note 1)	C_j	110	80				pF
Typical thermal resistance (Note 2)	$R_{\theta JA}$	95					°C/W
Operating junction temperature range	T_J	-55 ~ +125					°C
Storage temperature range	T_{stg}	-55 ~ +150					°C

Notes: 1. Measured at 1 MHz and applied reverse voltage of 4 V D.C
2. P.C.B. mounted with 2.0" X 2.0" (5 X 5 cm) copper pad areas.

Company reserves the right to improve product design, functions and reliability without notice.

REV:A

Rating and Characteristic Curves (SS14F-HF Thru. SS120F-HF)

Fig.1 - Forward Current Derating Curve

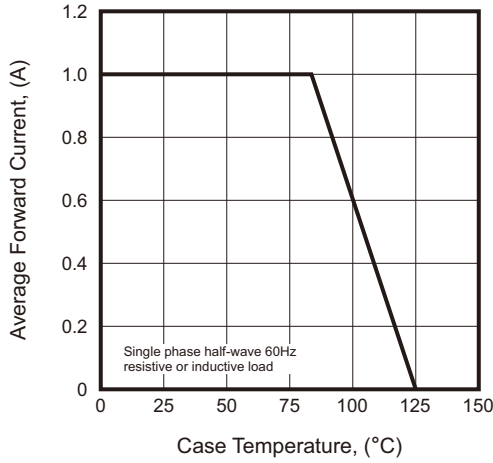

Fig.2 - Typical Reverse Characteristics

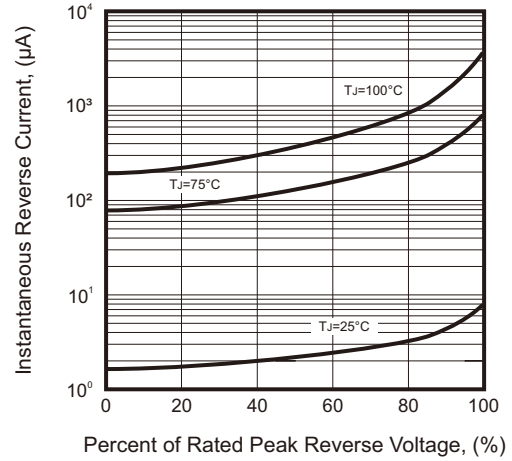

Fig.3 - Typical Forward Characteristic

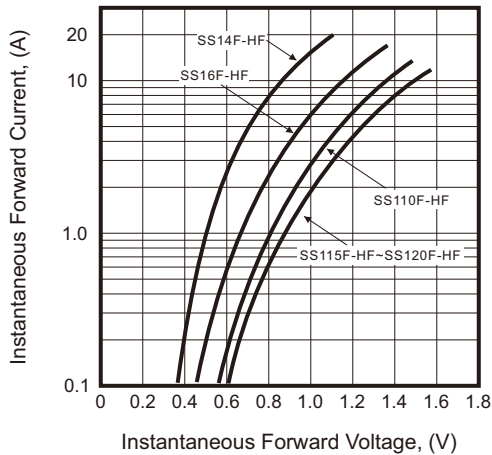

Fig.4 - Typical Junction Capacitance

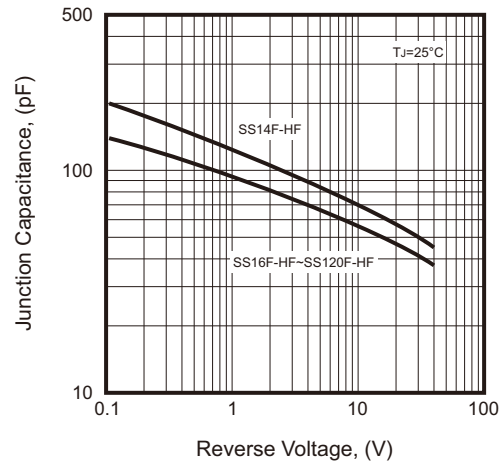

Fig.5 - Maximum Non-Repetitive Peak Forward Surge Current

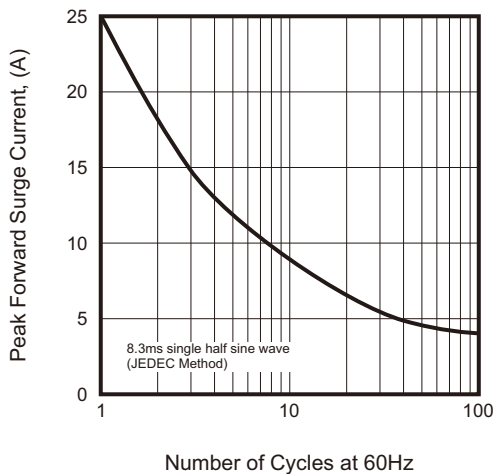
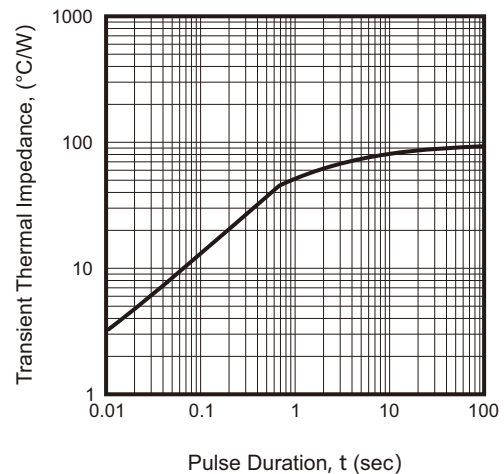
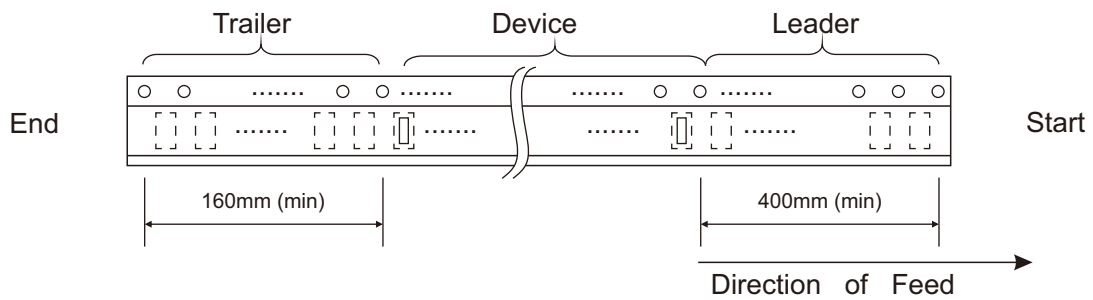
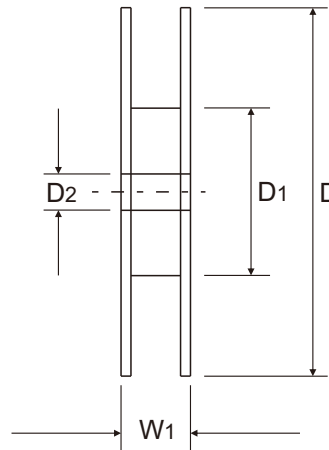
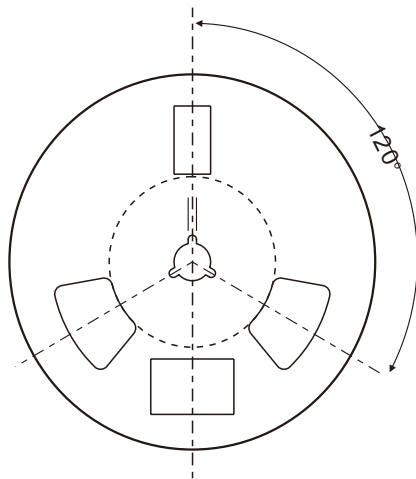
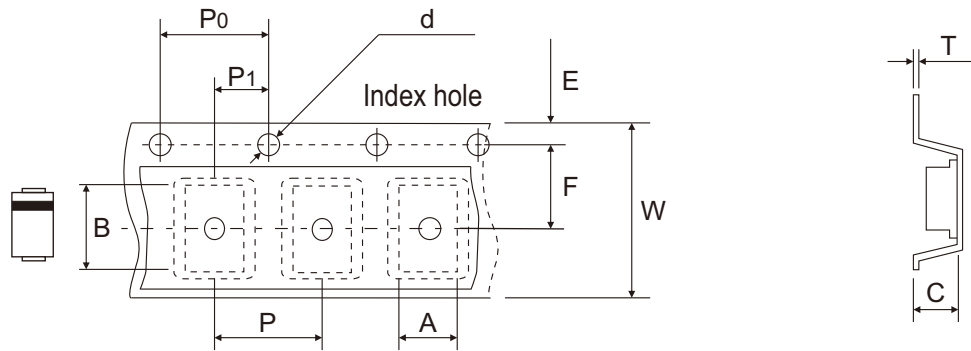

Fig.6 - Typical Transient Thermal Impedance



Company reserves the right to improve product design, functions and reliability without notice.

Reel Taping Specification



SMAF	SYMBOL	A	B	C	d	D	D1	D2
	(mm)	2.93 ± 0.10	5.33 ± 0.10	1.33 ± 0.10	1.55 ± 0.05	330 ± 2.00	75.00 ± 1.00	13.00 ± 0.20
	(inch)	0.115 ± 0.004	0.210 ± 0.004	0.052 ± 0.004	0.061 ± 0.002	12.992 ± 0.079	2.953 ± 0.039	0.512 ± 0.008

SMAF	SYMBOL	E	F	P	P0	P1	T	W	W1
	(mm)	1.73 ± 0.10	5.50 ± 0.10	4.00 ± 0.10	4.00 ± 0.10	2.00 ± 0.10	0.20 ± 0.03	12.00 ± 0.30	14.70 + 2.00 - 1.00
	(inch)	0.068 ± 0.004	0.217 ± 0.004	0.157 ± 0.004	0.157 ± 0.004	0.079 ± 0.004	0.008 ± 0.001	0.472 ± 0.012	0.579 + 0.079 - 0.039

Company reserves the right to improve product design, functions and reliability without notice.

REV:A

Marking Code

Part Number	Marking Code
SS14F-HF	SS14
SS16F-HF	SS16
SS110F-HF	SS110
SS115F-HF	SS115
SS120F-HF	SS120

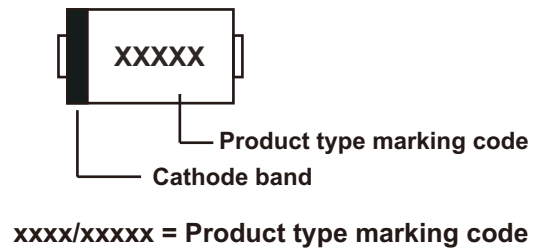

Suggested PAD Layout

SIZE	SMAF	
	(mm)	(inch)
A	2.20	0.087
B	1.60	0.063
C	1.80	0.071
D	5.40	0.213

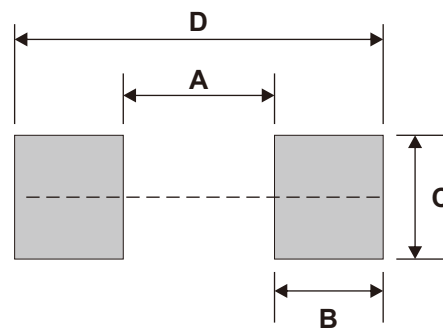

Note: 1. The pad layout is for reference purpose only.

Standard Packaging

Case Type	REEL PACK	
	REEL (pcs)	Reel Size (inch)
SMAF	10,000	13

Mouser Electronics

Authorized Distributor

Click to View Pricing, Inventory, Delivery & Lifecycle Information:

[Comchip Technology:](#)

[SS115F-HF](#) [SS16F-HF](#) [SS110F-HF](#) [SS14F-HF](#) [SS120F-HF](#)